

REVISIONS				
ZONE	LTR	DESCRIPTION	DATE	APPR.

IN GCK2_CLK_N<4..1>
 IN GCK2_CLK_P<4..1>
 IN GCK1_CLK_N<4..1>
 IN GCK1_CLK_P<4..1>

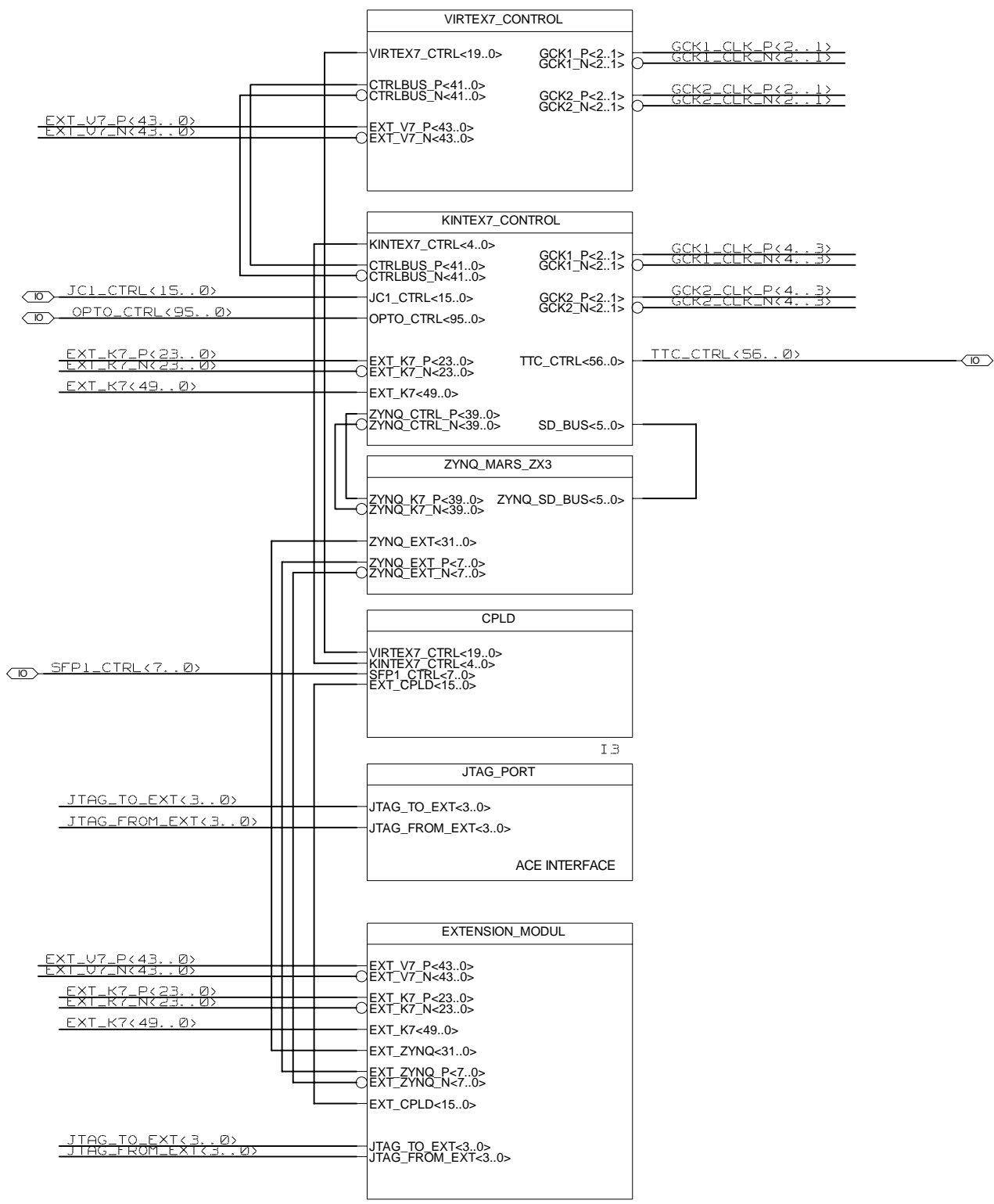

UNIVERSITY OF MAINZ	DRAWING TITLE		
	BOARDCONTROL		
	SIZE C	REV.	DRAWING NO.
SCALE	SHEET		OF

REVISIONS				
ZONE	LTR	DESCRIPTION	DATE	APPR.

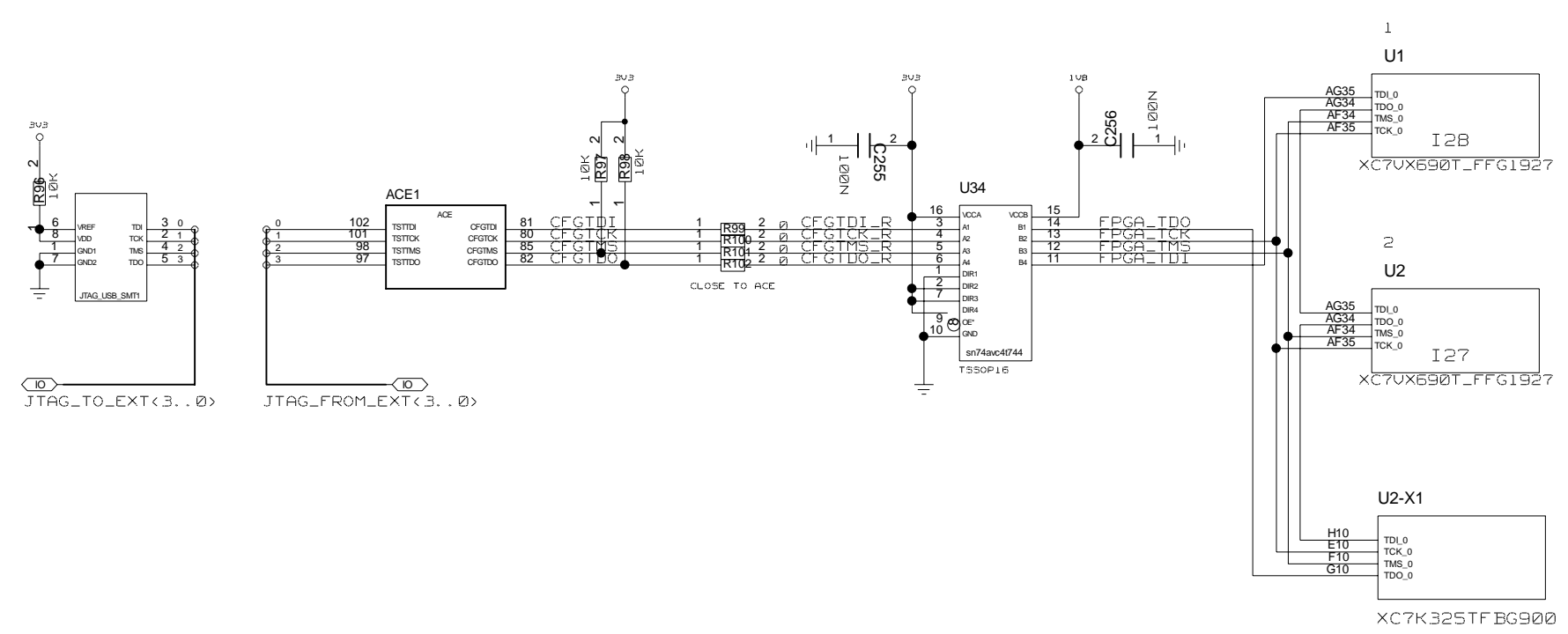

UNIVERSITY OF MAINZ		DRAWING TITLE	
		JTAG + ACE INTERFACE	
SIZE	REV.	DRAWING NO.	
C			
SCALE			SHEET OF

REVISIONS				
ZONE	LTR	DESCRIPTION	DATE	APPR.

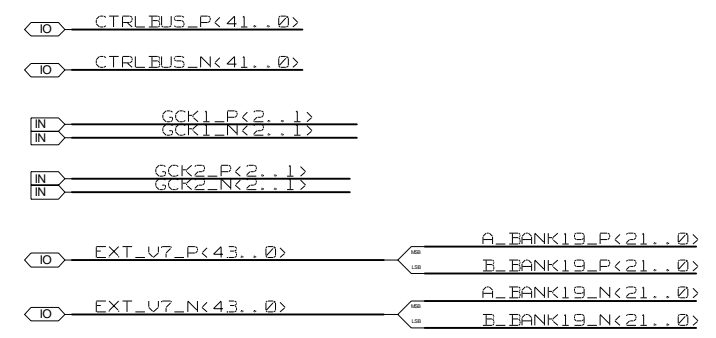

VIRTEX7_CTRL<19..0>

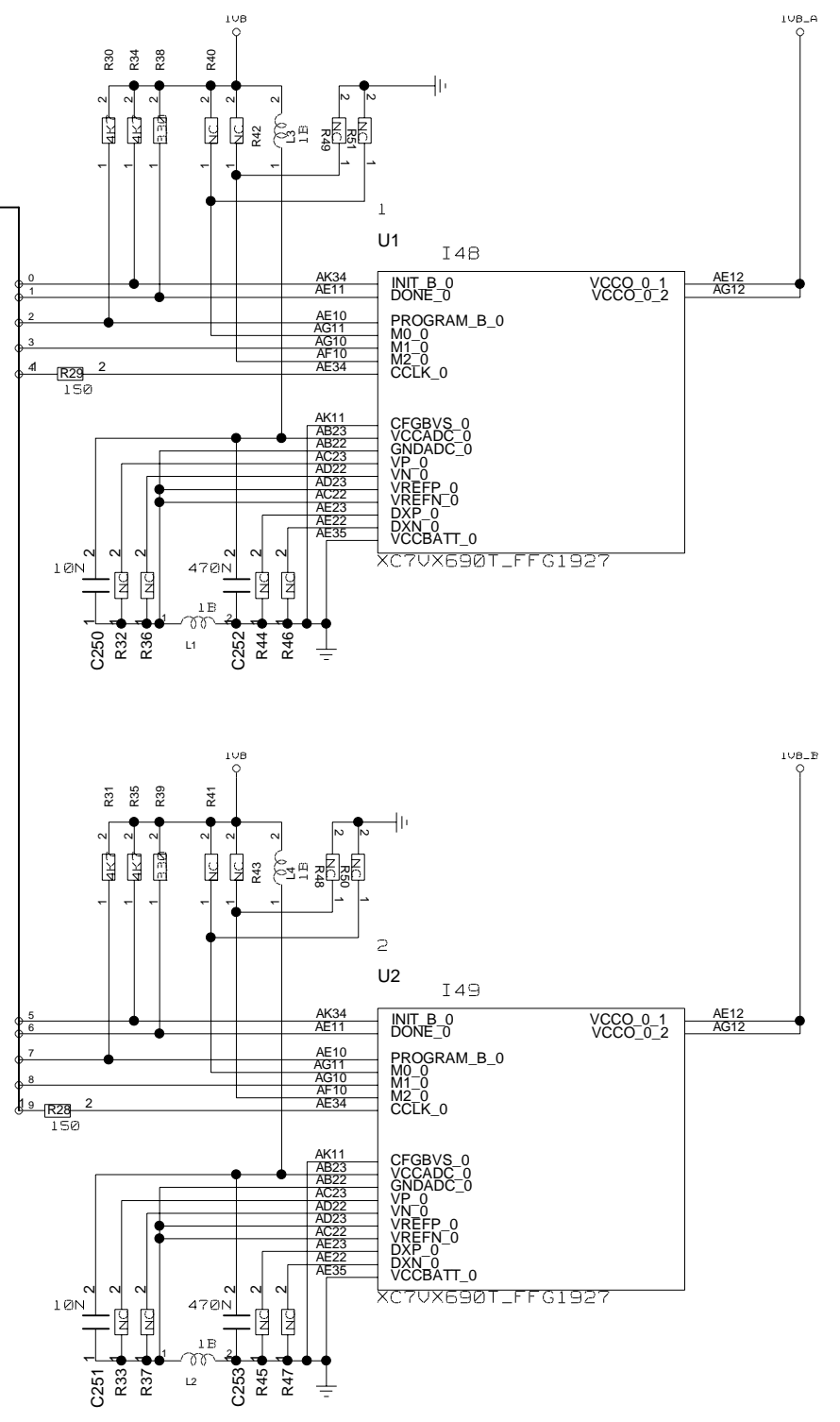

UNIVERSITY OF MAINZ		DRAWING TITLE	
VIRTEX7		CONTROL	
SIZE	REV.	DRAWING NO.	
C			
SCALE			SHEET OF

REVISIONS				
ZONE	LTR	DESCRIPTION	DATE	APPR.

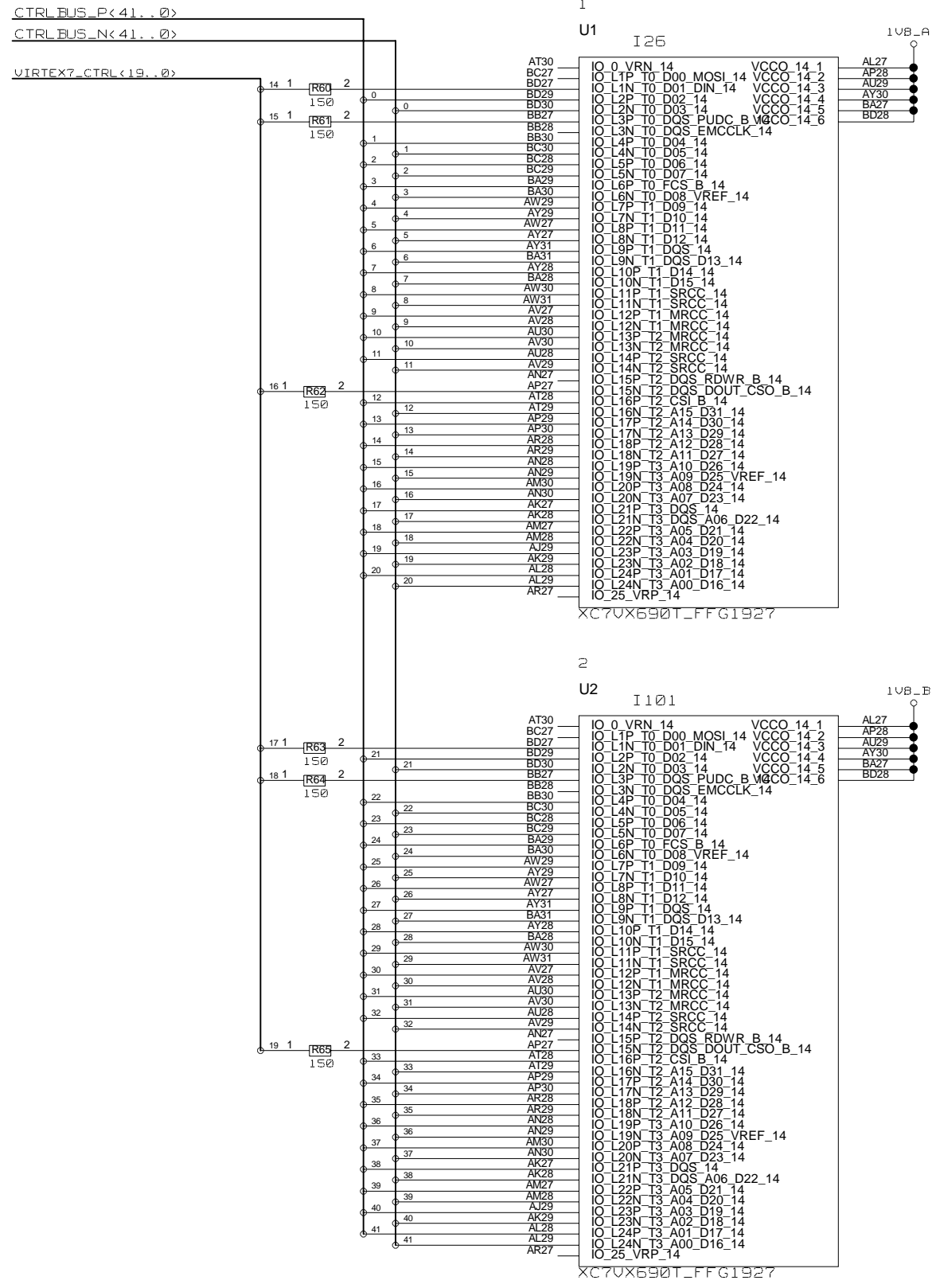

UNIVERSITY OF MAINZ	DRAWING TITLE	
	CONTROLBUS U1 + U2 --> KINTEX7	
VIRTEX7	SIZE C	DRAWING NO.
	SCALE	SHEET OF

REVISIONS				
ZONE	LTR	DESCRIPTION	DATE	APPR.

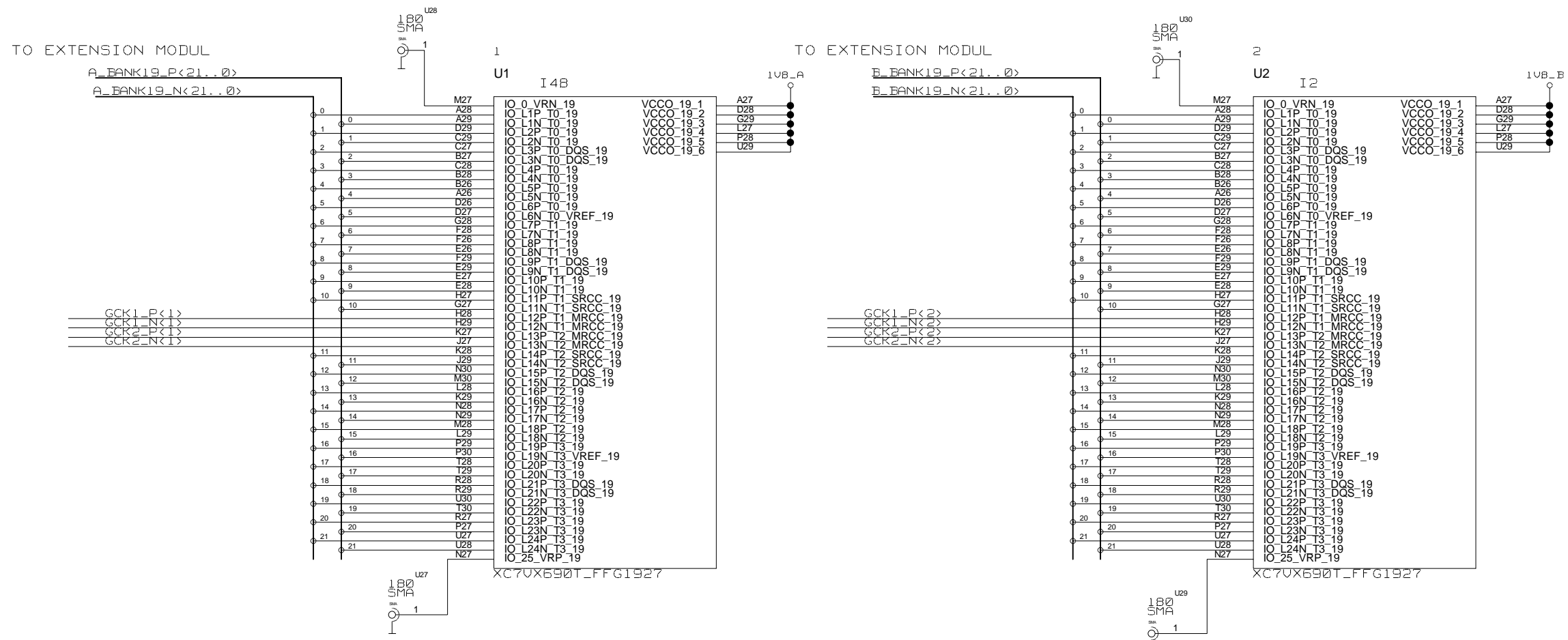

UNIVERSITY OF MAINZ		DRAWING TITLE	
VIRTEX7		TO EXTENSION MODUL	
SIZE C	REV.	DRAWING NO.	
SCALE		SHEET OF	

REVISIONS				
ZONE	LTR	DESCRIPTION	DATE	APPR.

CTRL_BUS_P<41..0>
CTRL_BUS_N<41..0>

JC1_CTRL<15..0>
TTC_CTRL<56..0>

ZYNQ_CTRL_P<39..0>
ZYNQ_CTRL_N<39..0>

EXT_K7_P<23..0>
EXT_K7_N<23..0>
EXT_K7<49..0>

TO EXTENSION MODUL

GCK1_P<2..1>
GCK1_N<2..1>

GCK2_P<2..1>
GCK2_N<2..1>

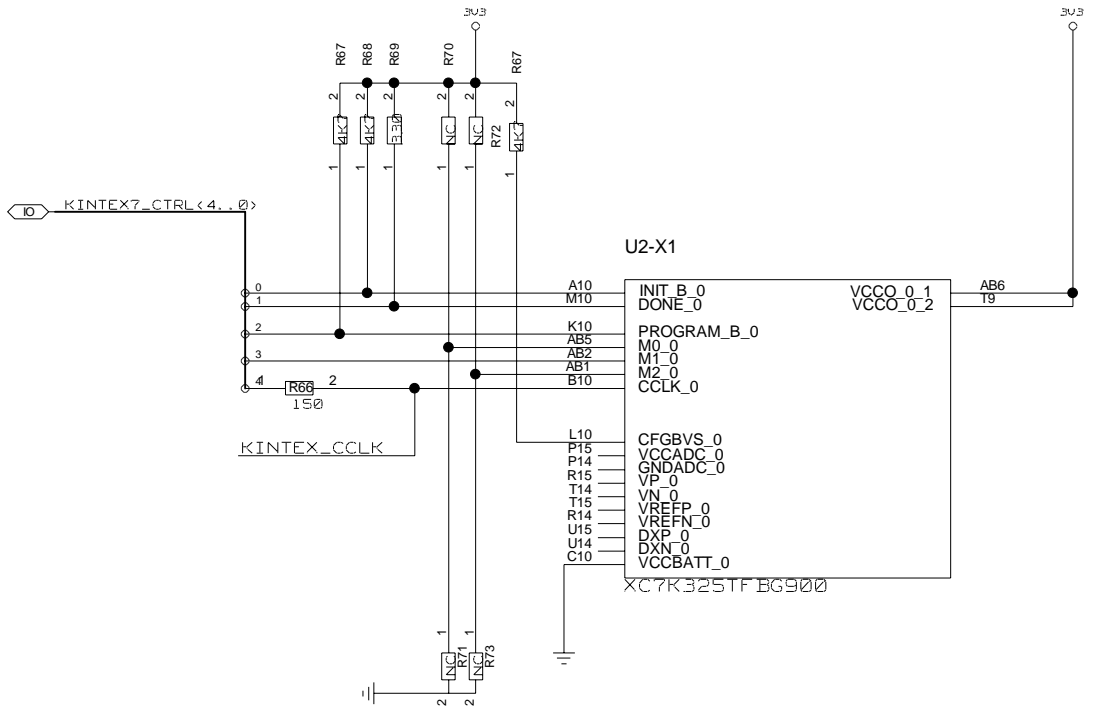

OPTO_CTRL<95..0>

OPTO_CTRL1<31..0>
OPTO_CTRL2<31..0>
OPTO_CTRL3<31..0>

OPTO_CTRL_K<7..0>
SFP_DAQ_CTRL<7..0>
SFP_ROI_CTRL<7..0>
SFP_UMF_CTRL<7..0>

UNIVERSITY OF MAINZ		DRAWING TITLE	
KINTEX7		CONTROL	
SIZE C	REV.	DRAWING NO.	
SCALE			SHEET OF

REVISIONS				
ZONE	LTR	DESCRIPTION	DATE	APPR.

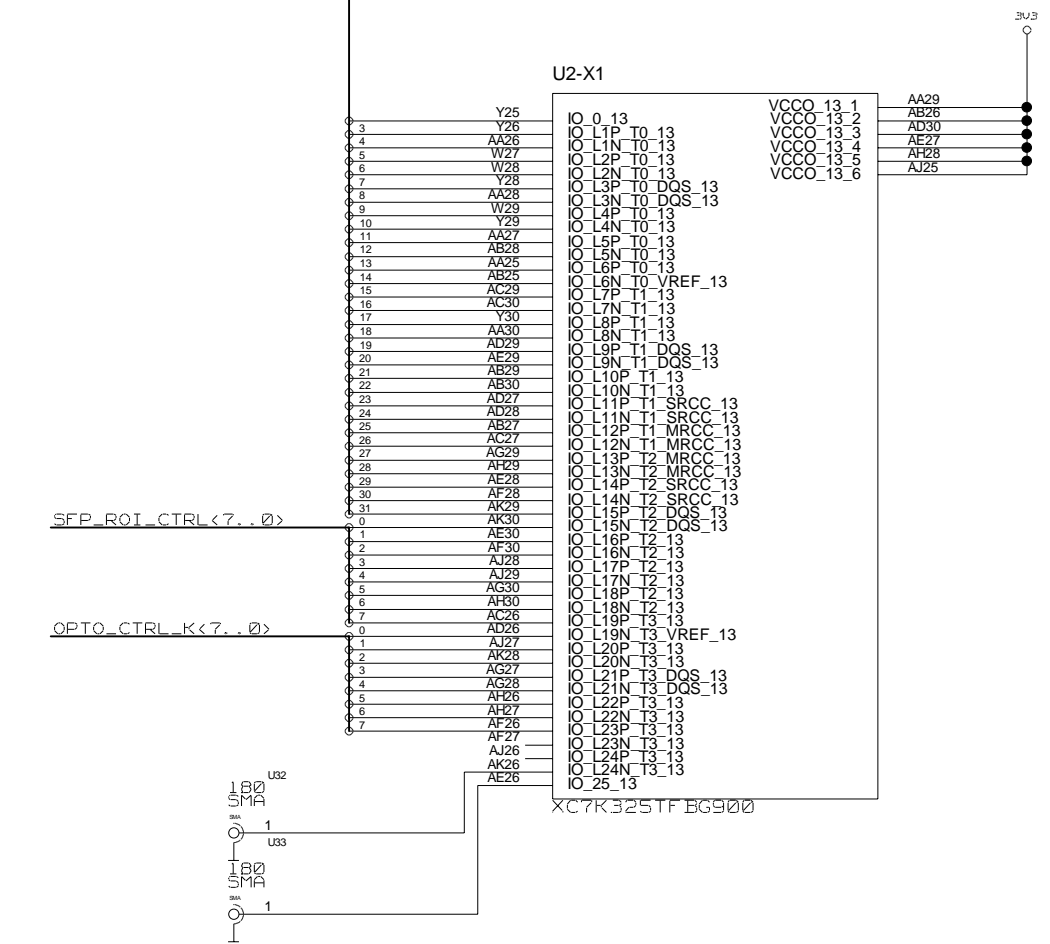
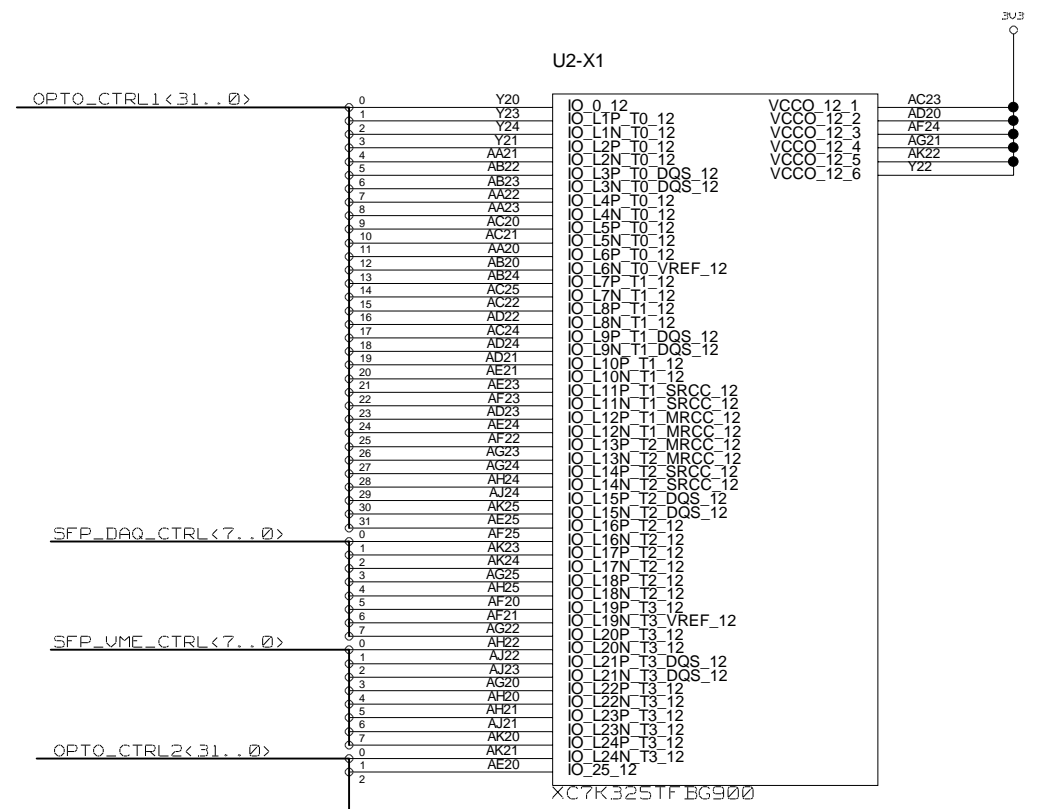

UNIVERSITY OF MAINZ	DRAWING TITLE		
	CONTROL AVAGO, SFP (DAQ, ROI, UME)		
KINTEX7	SIZE C	REV.	DRAWING NO.
	SCALE		SHEET OF

REVISIONS				
ZONE	LTR	DESCRIPTION	DATE	APPR.

BANK14 VCCO ABHAENGIG VON SPI SPANNUNG

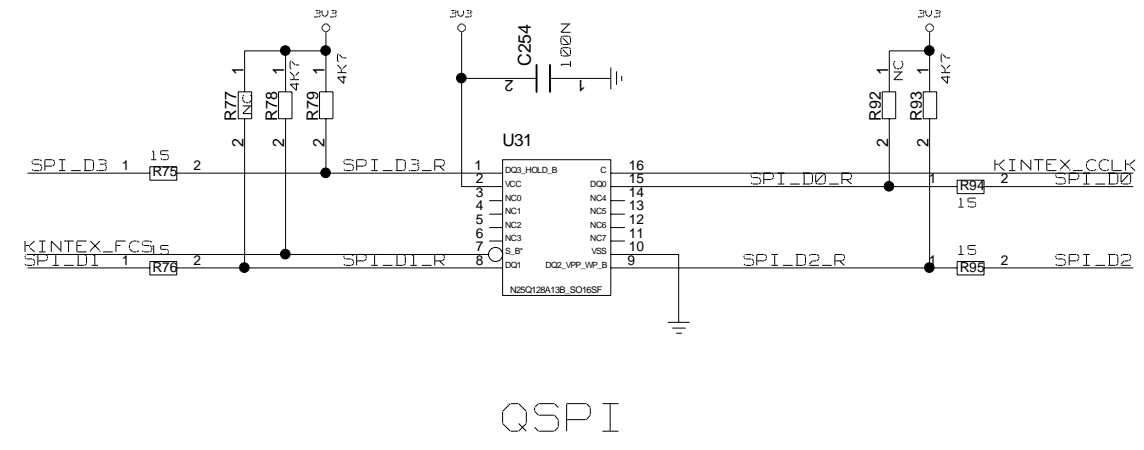
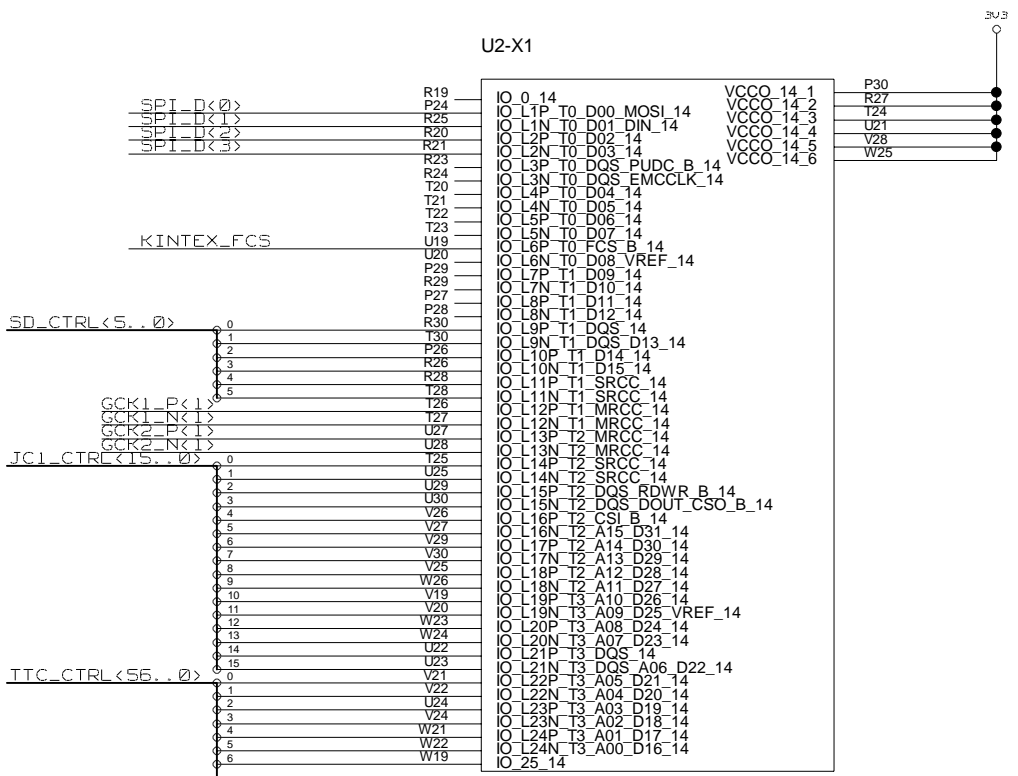

QSPI

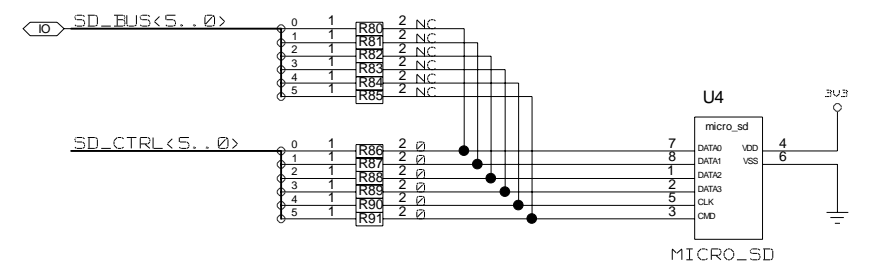
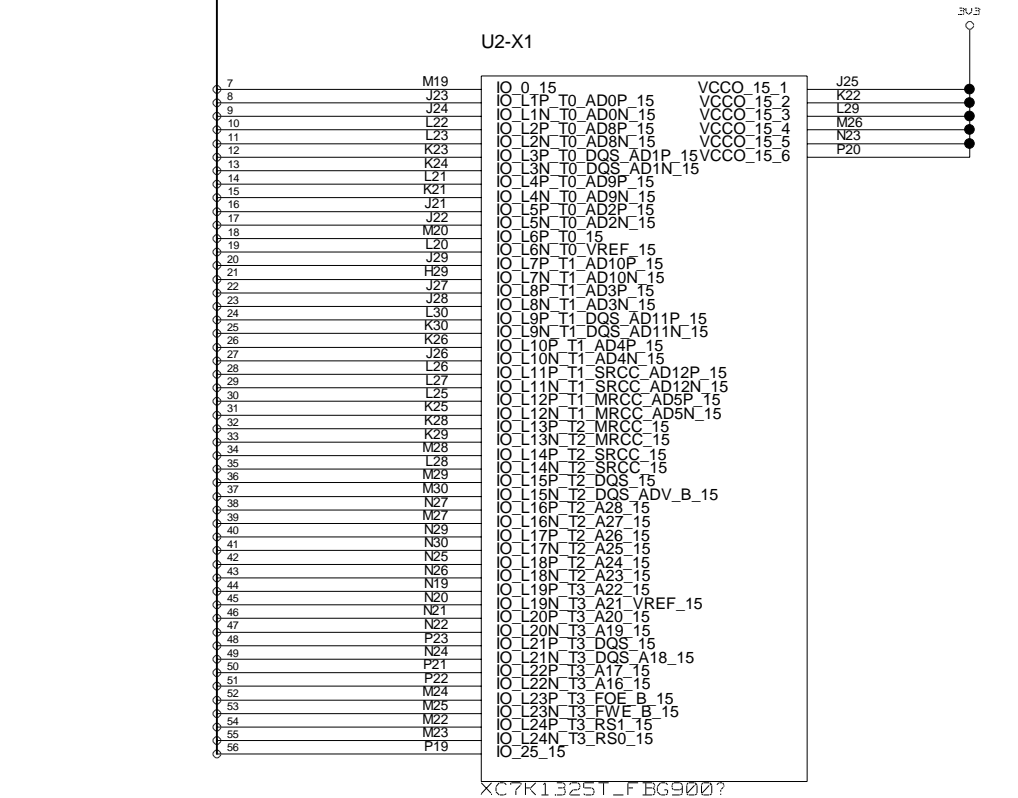

UNIVERSITY OF MAINZ		DRAWING TITLE	
KINTEX7		QSPI	
SIZE	REV.	DRAWING NO.	
C			
SCALE			SHEET OF

REVISIONS				
ZONE	LTR	DESCRIPTION	DATE	APPR.

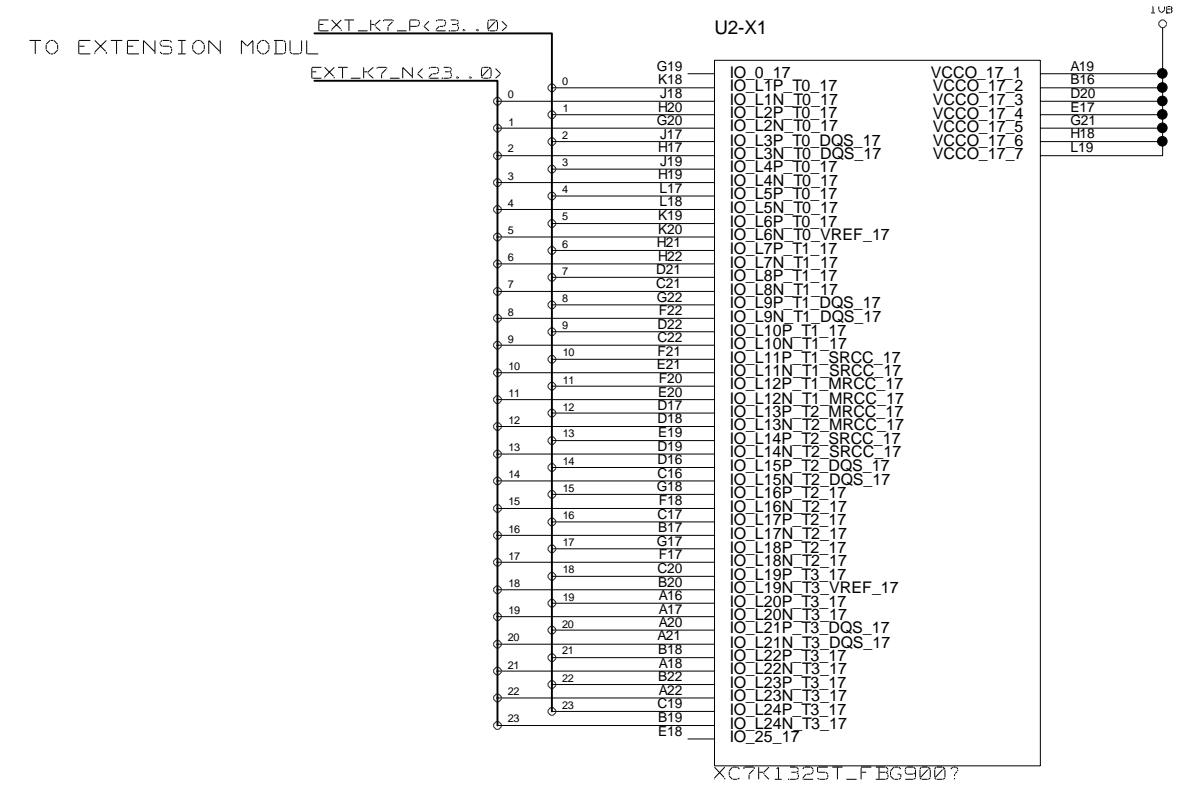
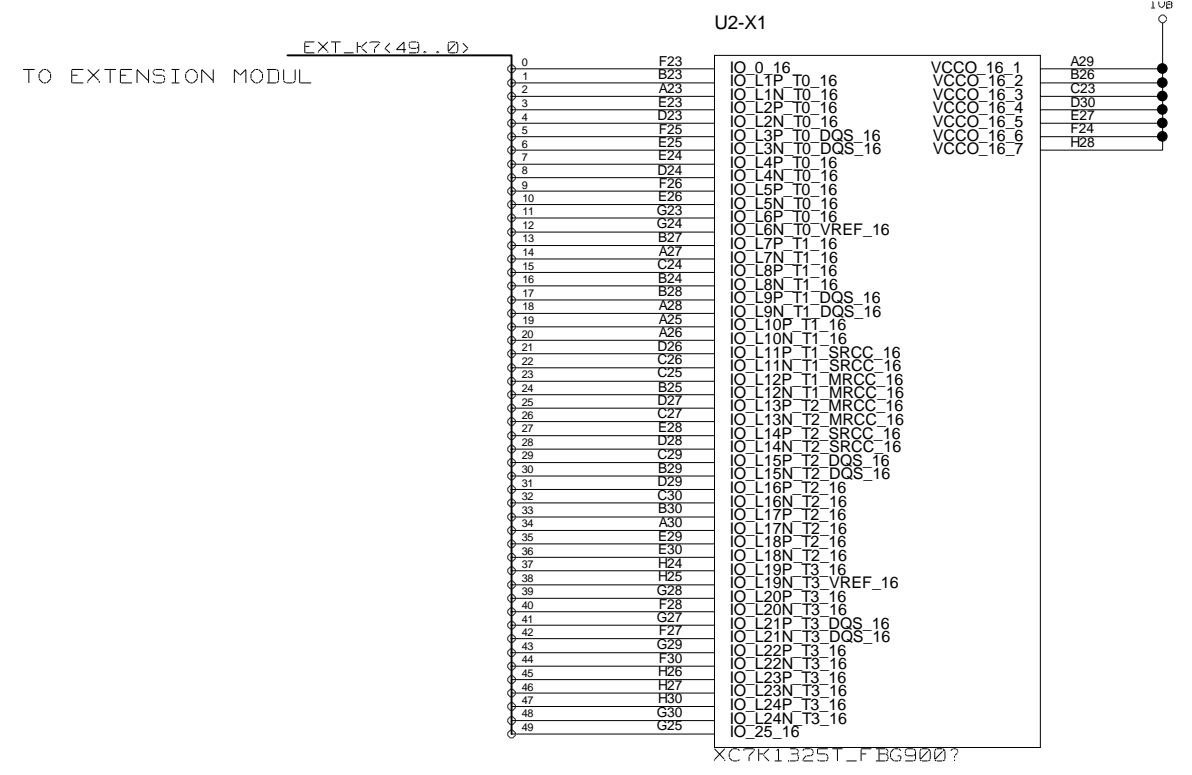

UNIVERSITY OF MAINZ	DRAWING TITLE		
	CONTROL EXTENSIONMODUL		
KINTEX7	SIZE	REV.	DRAWING NO.
	C		
SCALE			SHEET OF

REVISIONS				
ZONE	LTR	DESCRIPTION	DATE	APPR.

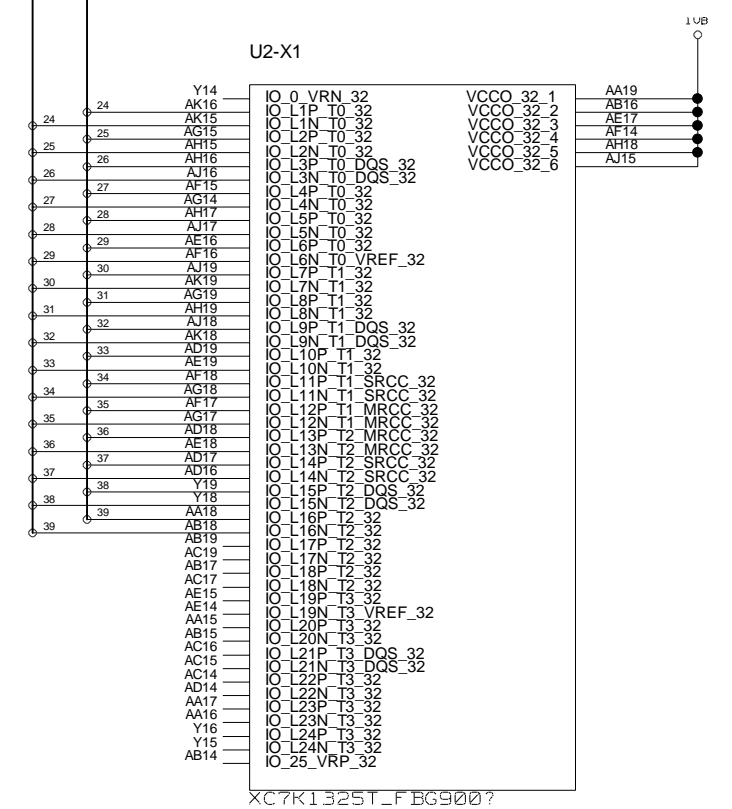
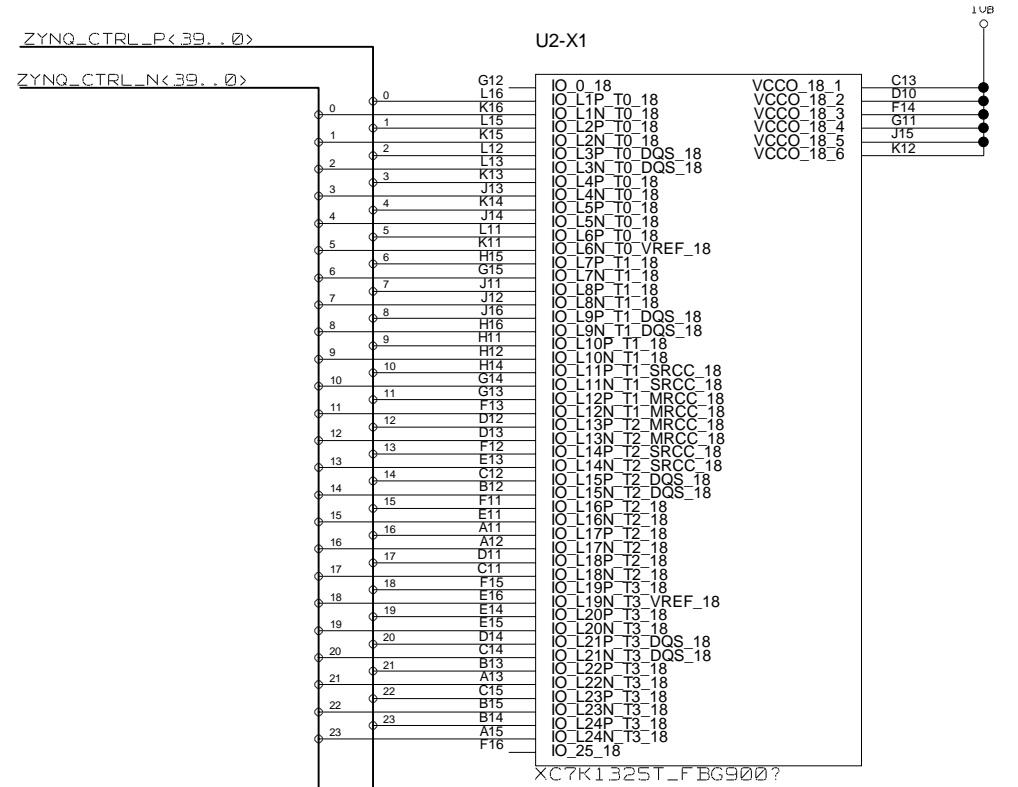

UNIVERSITY OF MAINZ	DRAWING TITLE		
	ZYNQ_CONTROL		
KINTEX7	SIZE	REV.	DRAWING NO.
	C		
SCALE			SHEET OF

REVISIONS				
ZONE	LTR	DESCRIPTION	DATE	APPR.

TO VIRTEX7_A/B

CTRLBUS_P<41..0>
CTRLBUS_N<41..0>

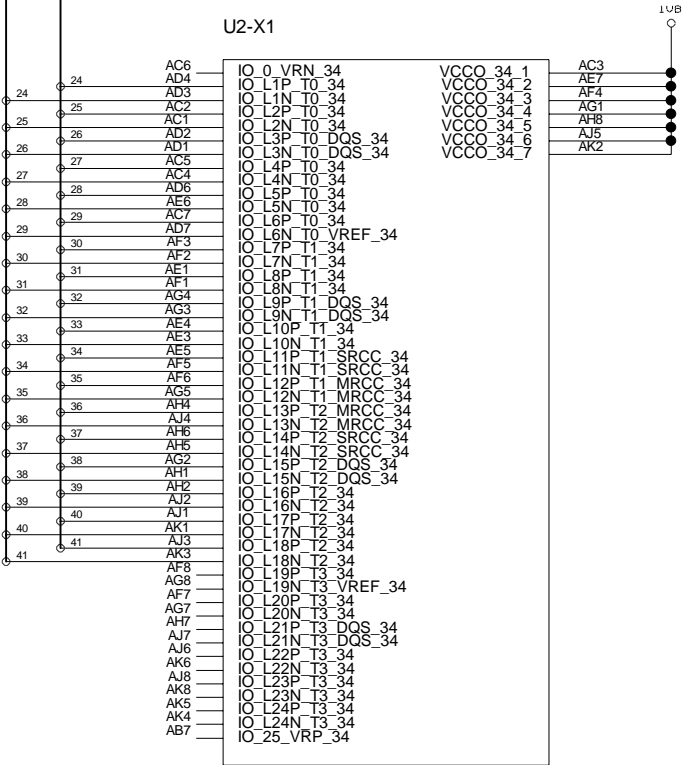
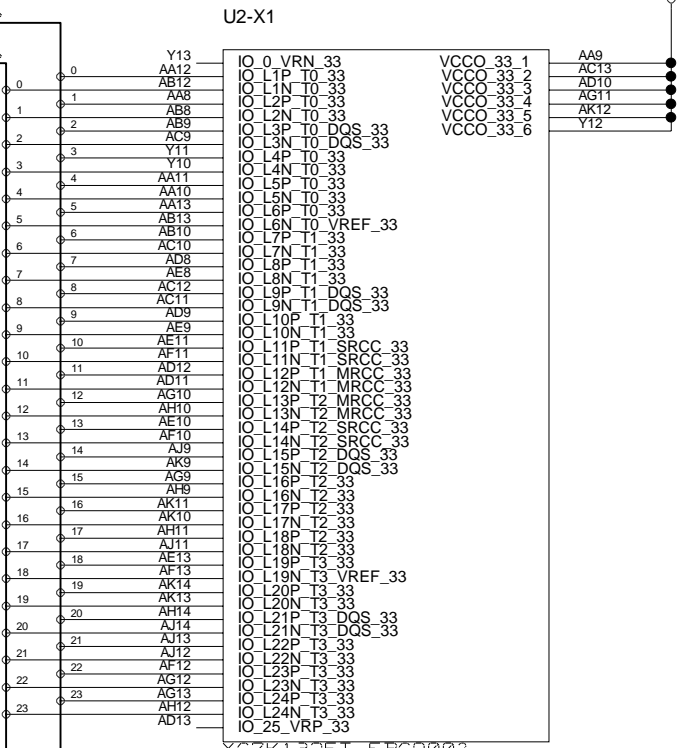

UNIVERSITY OF MAINZ	DRAWING TITLE	
	CONTROLBUS KINTEX7 ---> VIRTEX7	
KINTEX7	SIZE	DRAWING NO.
	C	REV.
SCALE	SHEET OF	

REVISIONS				
ZONE	LTR	DESCRIPTION	DATE	APPR.

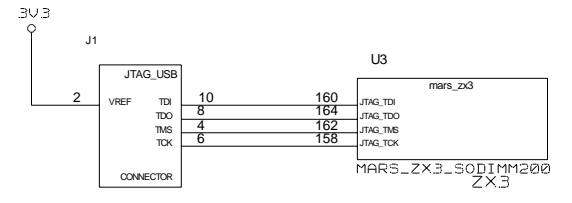
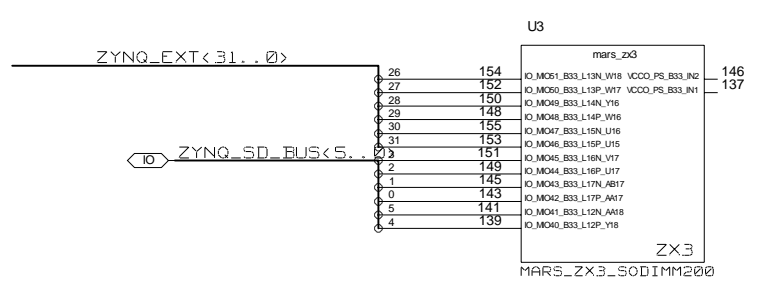
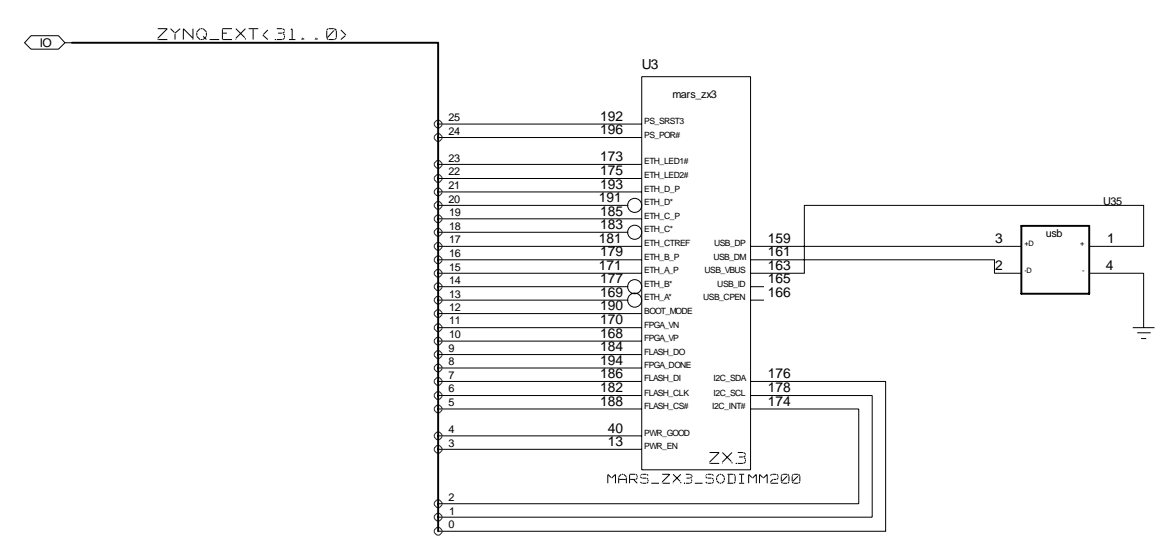
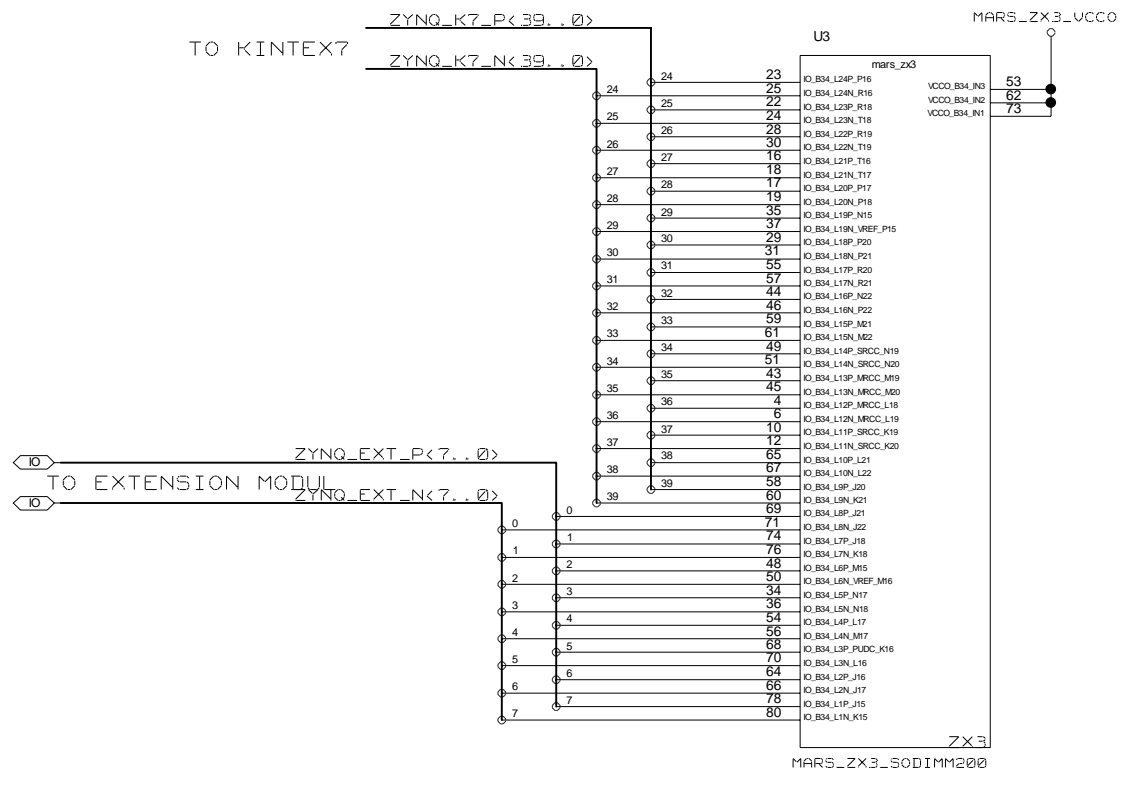
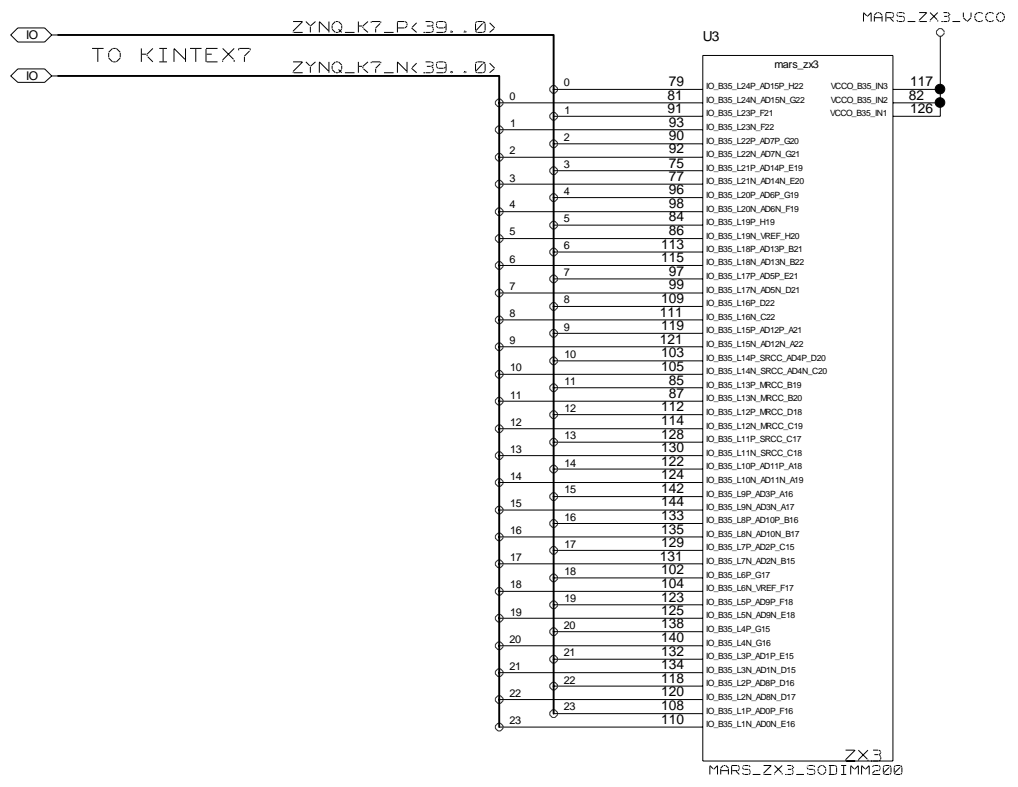
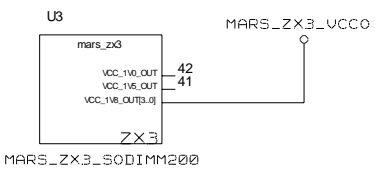

UNIVERSITY OF MAINZ

DRAWING TITLE		MARS_ZX3	
SIZE	REV.	DRAWING NO.	
C			
SCALE		SHEET OF	

REVISIONS				
ZONE	LTR	DESCRIPTION	DATE	APPR.

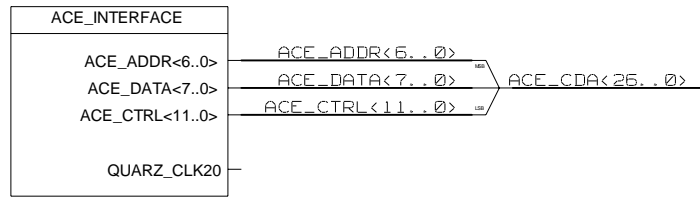
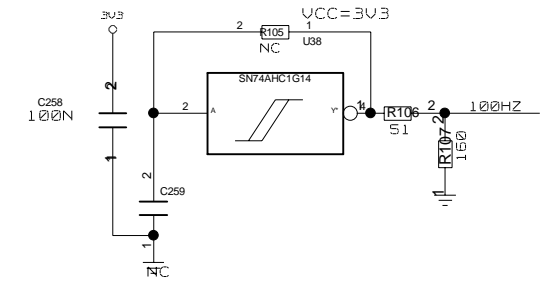
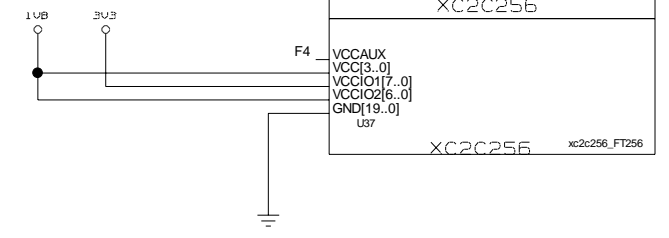
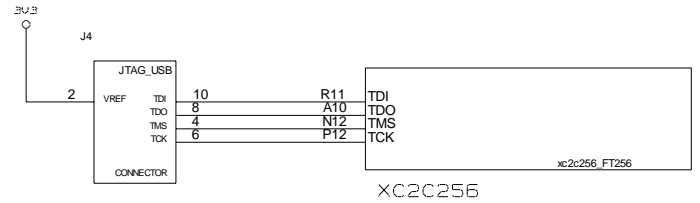
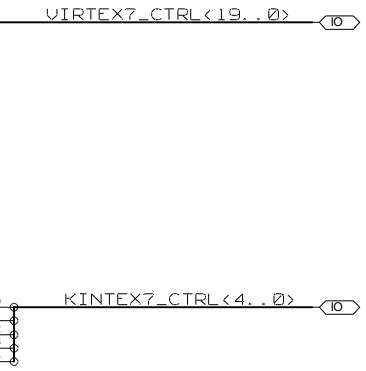
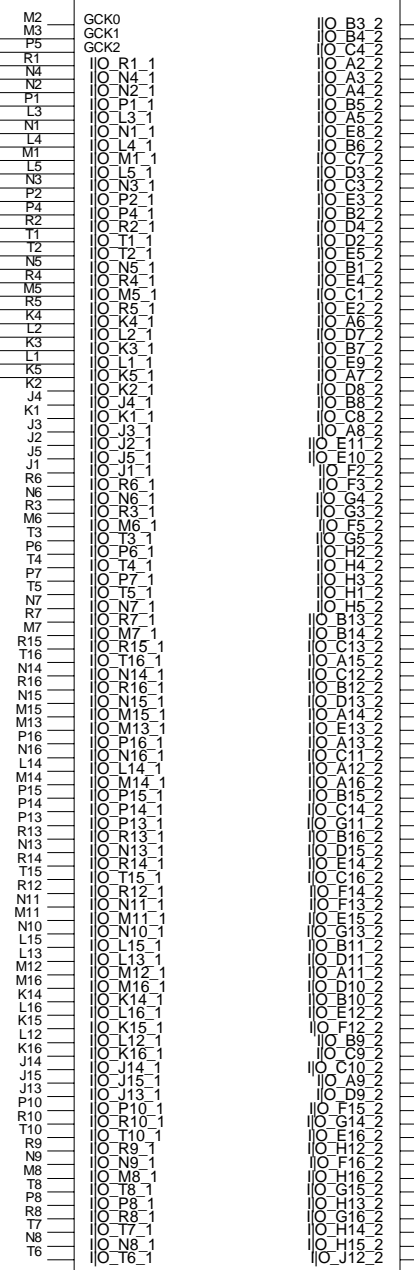
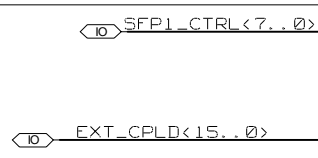
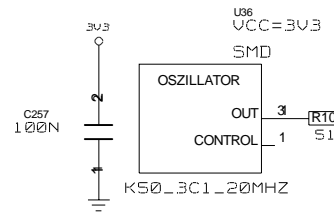

UNIVERSITY OF MAINZ	DRAWING TITLE		
	CONTROL + ACE		
CPLD	SIZE	REV.	DRAWING NO.
	C		
SCALE			SHEET OF

REVISIONS				
ZONE	LTR	DESCRIPTION	DATE	APPR.

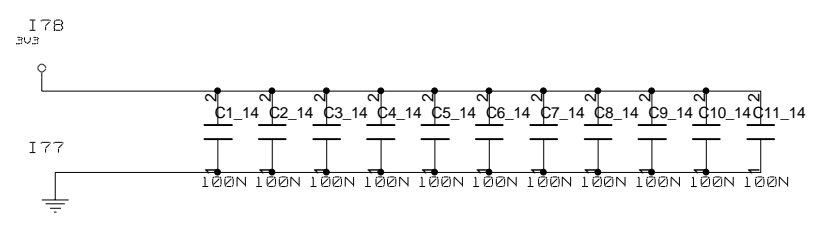
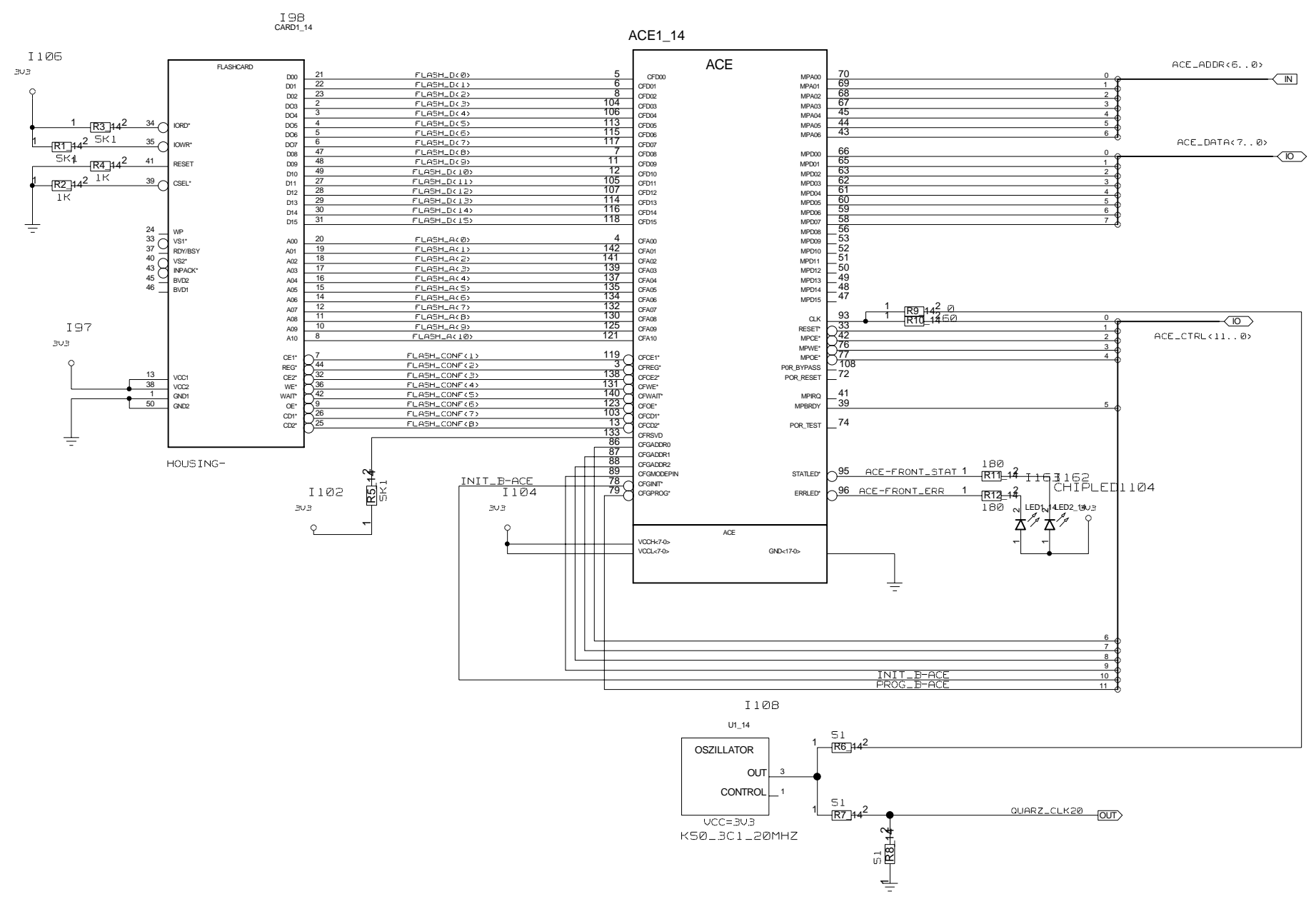

UNIVERSITY OF MAINZ		DRAWING TITLE	
CONTROL		ACE MODUL	
SIZE	REV.	DRAWING NO.	
C			
SCALE			SHEET OF

REVISIONS				
ZONE	LTR	DESCRIPTION	DATE	APPR.

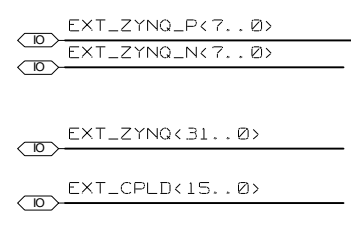
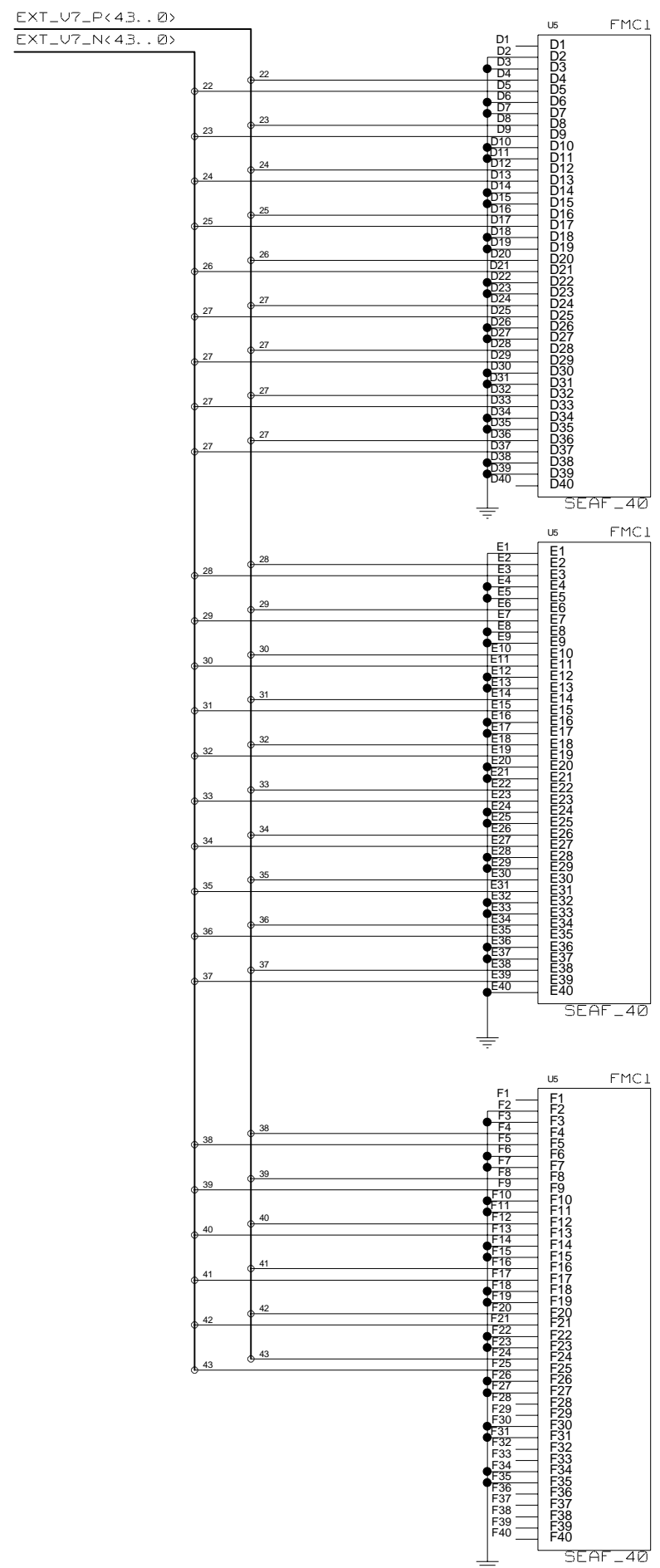
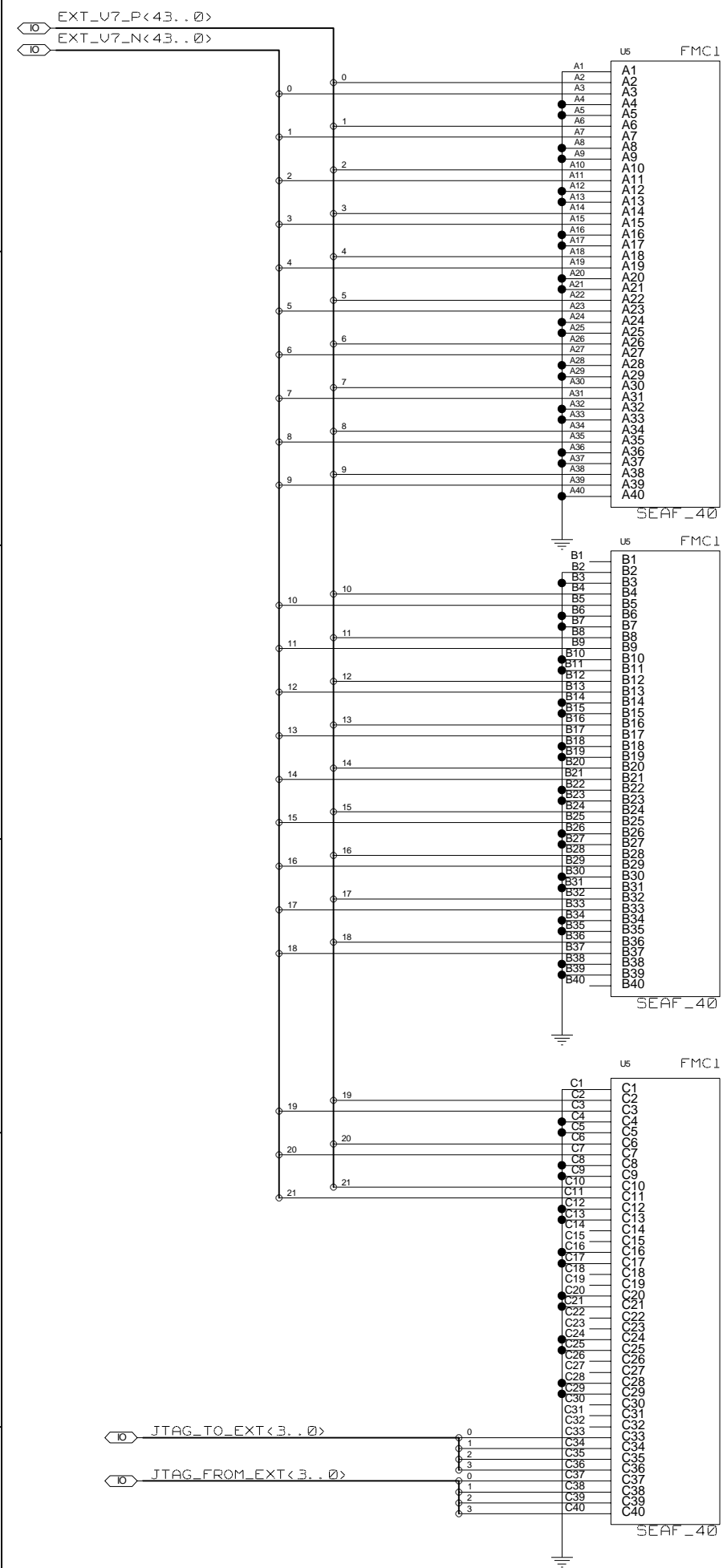

UNIVERSITY OF MAINZ	DRAWING TITLE		EXTENSION MODUL
	SIZE C	REV.	
SCALE		SHEET OF	

REVISIONS				
ZONE	LTR	DESCRIPTION	DATE	APPR.

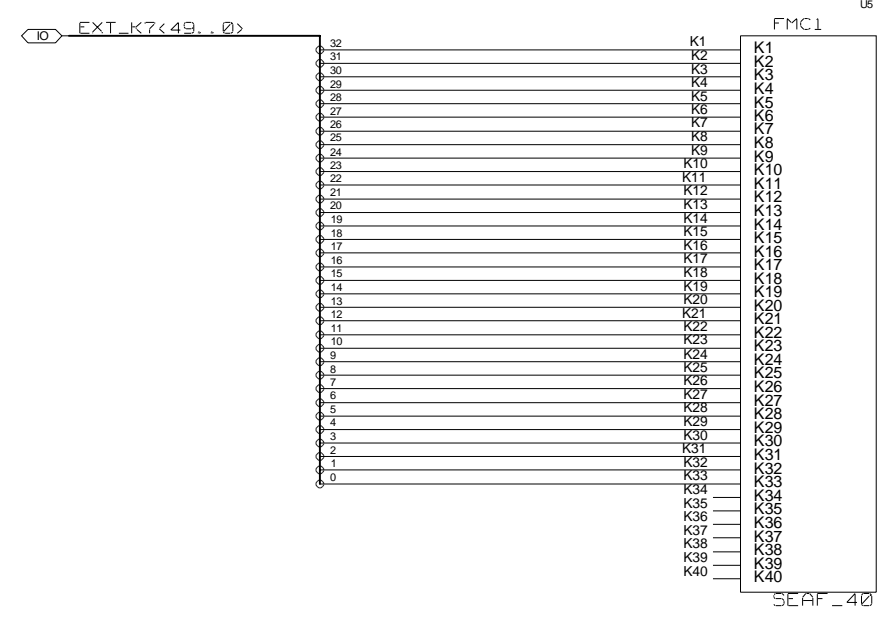
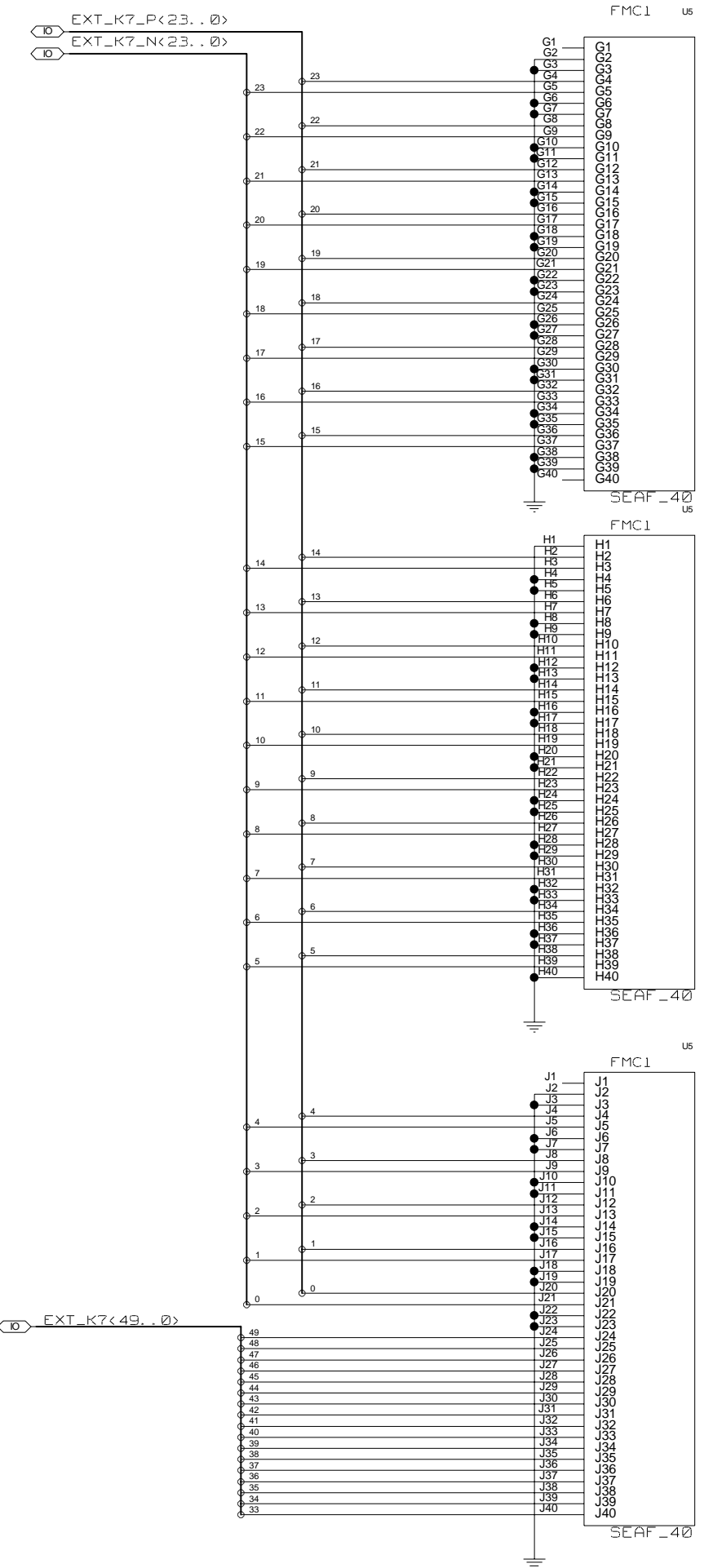

UNIVERSITY OF MAINZ	DRAWING TITLE		
	EXTENSION MODUL		
SIZE	REV.	DRAWING NO.	
C			
SCALE			SHEET OF